



Precast/Prestressed Concrete Institute

Acoustics



designer's notebook

ACOUSTICS

General

The basic purpose of architectural acoustics is to provide a satisfactory environment in which the desired sounds are clearly heard by the intended listeners and the unwanted sounds (noise) are isolated or absorbed. The sound-reduction needs of a building are determined based on location, environmental ambiance, and the degree of sound reduction necessary for occupants to function effectively.

Under most conditions, the architect can design the building to satisfy the acoustical needs of the tenant. Good acoustical design uses reflective and absorptive surfaces, sound barriers, and vibration isolators. Some surfaces must reflect sound so that the loudness will be adequate in all areas where listeners are located. Other surfaces must absorb sound to avoid echoes, sound distortion, and long reverberation times. Sound is isolated from rooms where it is not wanted by selected wall and floor/ceiling constructions. Vibrations generated by mechanical equipment are isolated from the structural frame of the building by means of mechanical isolators or compressible materials.

Most acoustical situations can be described in terms of: (1) sound source, strength, and path; (2) sound transmission path; and (3) sound receiver.

Sound Levels

The problems of sound insulation are usually considerably more complicated than those of sound absorption. Sound insulation involves greater reductions in sound level than can be achieved by absorption. These large reductions can only be achieved by continuous, impervious barriers. If the problem also involves structure-borne sound, it may be necessary to introduce resilient layers or discontinuities into the barrier.

Sound absorbing materials and sound insulating materials are used for two different purposes. There is not much sound absorption from an 8 in. (200 mm) concrete wall; similarly, low sound transmission is not available from a porous, lightweight material that may be applied to room surfaces for sound absorption. It is important to recognize that the basic mechanisms of sound absorption and sound insulation are quite different.

Sound Transmission Loss

Sound transmission loss measurements are made at 16 frequencies at one-third octave intervals covering the range from 125 to 4000 Hz. The testing procedure is described in ASTM E 90, *Laboratory Measurement of Airborne Sound Transmission Loss of Building Partitions*. Measurements can also be made in buildings by following ASTM E 336, *Measurement of Airborne Sound Insulation in Buildings*. To simplify specification of desired performance characteristics the single number Sound Transmission Class (STC) (see ASTM E 413) was developed. It was originally designed to assess sound (human speech) privacy for interior walls, but its use has expanded to cover virtually all types of partitions and partition elements.

Airborne sound reaching a wall, floor, or ceiling produces vibrations in the wall that are radiated with reduced intensity on the other side. Airborne sound transmission loss in wall assemblies is a function of their weight, stiffness, and vibration damping characteristics.

Weight is concrete's greatest asset when it is used as a sound insulator. For sections of similar design, but different weights, the STC increases approximately 6 units for each doubling of weight (**Fig. 1**). This figure describes sound transmission class as a function of weight based on experimental data. Precast concrete walls usually do not need additional treatments in order to provide adequate sound insulation. If desired, greater sound insulation can be obtained by using a resiliently attached layer(s) of gypsum board or other building material. The increased transmission loss occurs because the energy flow path is increased to include a dissipative air column and additional mass.

The acoustical test results of airborne sound transmission loss of 4, 6, and 8 in. (100, 150, and 200 mm) solid flat panels are shown in (**Fig. 2**). **Table 1** presents the ratings for various precast concrete assemblies. The effects of various assembly treatments on sound transmission can also be predicted from results of previous tests shown in **Table 2**. The improvements are additive, but in some cases the total effect may be slightly less than the sum.

The mass of the precast/prestressed concrete loadbearing sandwich wall panels prevented outside noises from entering the building in **Figure 3**. The design of this auditorium required selected areas of high resolution and reflectivity, which was achieved by using the 8 in.-thick (200 mm)

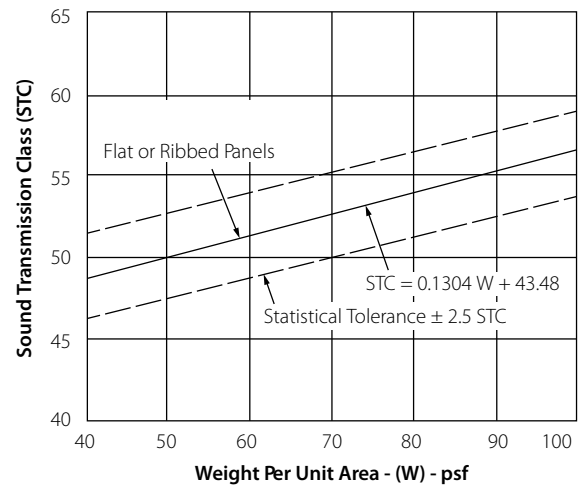

Figure 1 Sound transmission class as a function of wall weight.

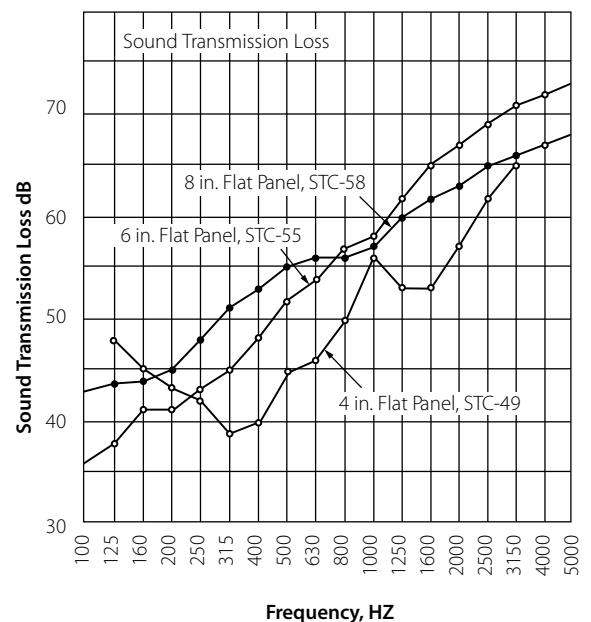

Figure 2 Acoustical test data of solid flat concrete panels – normal-weight concrete.

curved interior wall panels to distribute sound throughout the hall in a geometrically controlled fashion. They also serve as structural members. Some 200 curved, sandblasted panels, employing eight different radii, were created to meet all of the acoustical requirements. They were given a staining sealer for aesthetic effects.

Absorption of Sound

A sound wave always loses part of its energy as it is reflected by a surface. This loss of energy is called sound absorption. It appears as a decrease in sound pressure of the reflected wave. The sound absorption coefficient is the fraction of energy incident but not reflected per unit of surface area. Sound absorption can be specified at individual frequencies or as an average of absorption coefficients (NRC). A dense, non-porous concrete surface typically absorbs 1 to

Assembly	No. Description	STC ¹ (OITC)
1	4 in. flat panel, 54 psf	49 (43)
2	5 in. flat panel, 60 psf	52 ²
3	6 in. flat panel, 75 psf	55 (46)
4	Assembly 2 with "Z" furring channels, 1 in. insulation and 1/2 in. gypsum board, 75.5 psf	62
5	Assembly 2 with wood furring, 1 1/2 in. insulation and 1/2 in. gypsum board, 73 psf	63
6	Assembly 2 with 1/2 in. space, 1 5/8 in. metal stud row, 1 1/2 in. insulation and 1/2 in. gypsum board	63 ²
7	8 in. flat panel, 95 psf	58 (50)
8	10 in. flat panel, 120 psf	59 ²

1 The STC of sandwich panels is about the same as the STC of the thickness of the two concrete wythes (ignoring the insulation thickness).

2 Estimated values.

Table 1 Airborne Sound Transmission Class Ratings from Tests of Precast Concrete Assemblies.

Treatment	Increased Airborne STC
Wall furring, 3/4 in. insulation and 1/2 in. gypsum board attached to concrete wall	3
Separate metal stud system, 1 1/2 in. insulation in stud cavity and 1/2 in. gypsum board attached to concrete wall	5 to 10
Plaster direct to concrete	0

Table 2 Typical Improvements for Wall Treatments Used with Precast Concrete Elements.

2% of incident sound and has an NRC of 0.015. In cases where additional sound absorption is desired, a coating of acoustical material can be spray-applied, acoustical tile can be applied with adhesive, or an acoustical ceiling can be suspended. Most of the spray-applied fire-retardant materials used to increase the fire resistance of precast concrete and other floor-ceiling systems can also be used to absorb sound. The NRC of the sprayed fiber types range from 0.25 to 0.75. Most cementitious types have an NRC from 0.25 to 0.50.

Acceptable Noise Criteria

As a rule, a certain amount of continuous sound can be tolerated before it becomes noise. An “acceptable” level neither disturbs room occupants nor interferes with the communication of wanted sound.

The most generally accepted noise criteria (NC) used today are expressed as the Noise Criteria or the Room Criteria (RC) curves (**Fig. 4, Table 3 and Fig. 5**). The figures in **Table 4** represent general acoustical goals. They can also be compared with anticipated noise levels in specific rooms to assist in evaluating noise-reduction problems.

The main criticism of NC curves is that they are too permissive when the control of low or high frequency noise is of concern. For this reason, room criteria (RC) curves were developed (Fig. 5). RC curves are the result of extensive studies based on the human response to both sound-pressure level and frequency and take into account the requirements for speech intelligibility.

A low background level obviously is necessary where listening and speech intelligibility is important. Conversely, higher ambient levels can persist in large business offices or factories where speech communication is limited to short distances. Often, the minimum target levels are just as important as the maximum permissible levels listed in Table 4. In an office or residence, it is desirable to have a certain ambient sound level to assure adequate acoustical privacy between spaces and minimize the transmission loss requirements of unwanted sound (noise).

These undesirable sounds may be from exterior sources such as automo-



Figure 3 The Juanita K. Hammons Hall for the Performing Arts, Springfield, Missouri; Architect: Pellham-Phillips-Hagerman and Butler, Rosenbury & Partners (joint venture); (Photos Pellham-Phillips-Hagerman)

Noise Criteria Curves	Octave Band Center Frequency, Hz							
	63	125	250	500	1000	2000	4000	8000
NC-151	47	36	29	22	17	14	12	11
NC-201	51	40	33	26	22	19	17	16
NC-251	54	44	37	31	27	24	22	21
NC-30	57	48	41	35	31	29	28	27
NC-35	60	52	45	40	36	34	33	32
NC-40	64	56	50	45	41	39	38	37
NC-45	67	60	54	49	46	44	43	42
NC-50	71	64	58	54	51	49	48	47
NC-55	74	67	62	58	56	54	53	52
NC-60	77	71	67	63	61	59	58	57
NC-65	80	75	71	68	66	64	63	62

¹ The applications requiring background levels less than NC-25 are special purpose spaces in which an acoustical consultant should set the criteria.

Table 3 Data for noise criteria curves.

biles and aircraft, or they may be generated as speech in an adjacent classroom or music in an adjacent apartment. They may also be direct impact-induced sound such as footfalls on the floor above, rain on a lightweight roof construction, or vibrating mechanical equipment. Thus, the designer must always be ready to accept the task of analyzing the many potential sources of intruding sound as related to their frequency characteristics and the rates at which they occur. The level of toleration that is to be expected by those who will occupy the space must also be established. **Figures 6 and 7** are the spectral characteristics of common noise sources.

With these criteria, the problem of sound isolation now must be solved, namely the reduction process between the high, unwanted noise source and the desired ambient level. Once the objectives are established, the designer then should refer to available data (for example in Fig. 1 or Table 1) and select the system that best meets these requirements. In this respect, precast concrete systems have superior properties and can, with minimal effort, comply with these criteria. When the insulation value has not been specified, selection of the necessary barrier can be determined analytically by (a) identifying exterior and /or interior noise sources, and (b) by establishing acceptable interior noise criteria.

Example: Sound Insulation Criteria

Assume a precast concrete office building is to be erected adjacent to a major highway. Private and semiprivate offices will run along the perimeter of the structure. The first step is to determine the degree of insulation required of the exterior wall system (see Sound Pressure Level 1, page 10). The NC data is used because it is more familiar to and preferred by designers.

The 500 Hz requirement, 38 dB, can be used as the first approximation of the wall STC category. However, if windows are planned for the wall, a system of about 50–55 STC should be selected (see following composite wall discussion). Individual transmission loss performance values of this system are then compared to the calculated need (see Sound Pressure Level 2).

The selected wall should meet or exceed the insulation needs at all frequencies. However, to achieve the most efficient design conditions, certain limited deficiencies can be tolerated. Experience has shown that the maximum deficiencies are 3 dB at two frequencies or 5 dB on one frequency point.

Composite Wall Considerations

An acoustically composite wall is made up of elements of varying acoustical properties. Windows and doors are often the weak link in an otherwise effective sound barrier. Minimal effects on sound transmission loss will be achieved in most cases by proper selection of glass (**Table 5**). The control of sound transmission through windows requires large cavities between layers (multiple glazing), heavy layers (thicker glass), laminated glass, and reduction of the structural connection between layers (separate frames and sashes for inner and outer layers). Also, mounting of glass lites with soft neoprene edge gaskets may not be as effective at reducing sound transmission as systems that use wet seals (gunable sealants). The combination of wet seals with butyl tape or open cell foam dramatically reduces the potential for air infiltration, and therefore, flanking sound transmission. They certainly have to be as airtight as possible; usually fixed windows provide much better sound transmission control than operable windows.

Sound pressure impinging on the window framing will cause it to vibrate, transmitting sound to the building interior. Consequently, the window-glass performance cannot solely be relied on to reduce sound transmission to the building interior. The sound transmission of the window framing will result in higher levels of sound transmission through the glass and wall. Also, windowframing systems that allow greater amounts of air infiltration also allow greater sound transmission.

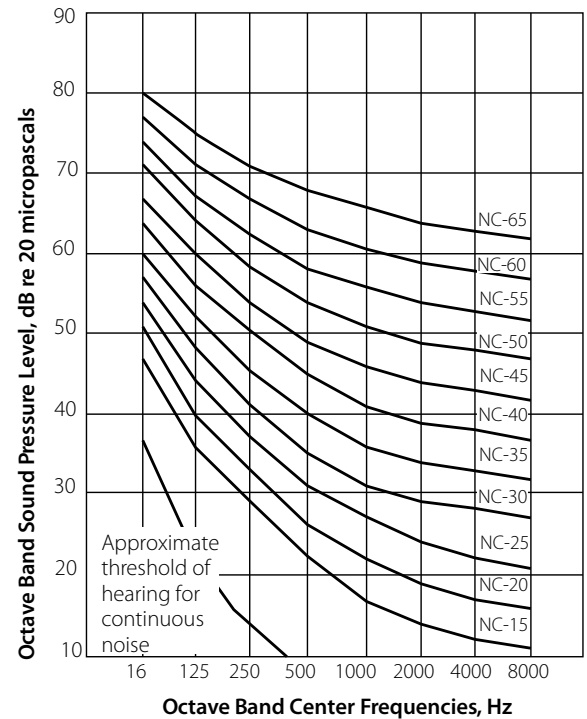

Figure 4 Noise criteria (NC) curves.

Type of Space	NC or RC Curve
1. Private residence	25 to 30
2. Apartments	30 to 35
3. Hotels/motels	
a. Individual rooms or suites	30 to 35
b. Meeting/banquet rooms	30 to 35
c. Halls, corridors, lobbies	35 to 40
d. Services/support areas	40 to 45
4. Offices	
a. Executive	25 to 30
b. Conference rooms	25 to 30
c. Private	30 to 35
d. Open-Plan areas	35 to 40
e. Computer/business machine areas	40 to 45
f. Public circulation	40 to 45
5. Hospitals and clinics	
a. Private rooms	25 to 30
b. Wards	30 to 35
c. Operating rooms	25 to 30
d. Laboratories	30 to 35
e. Corridors	30 to 35
f. Public areas	35 to 40
6. Churches	25 to 30 ²
7. Schools	
a. Lecture and classrooms	25 to 30
b. Open-Plan classrooms	30 to 35 ²
8. Libraries	30 to 35
9. Concert halls ²	
10. Legitimate theaters ²	
11. Recording studios ²	
12. Movie theaters	30 to 35

¹ Design goals can be increased by 5dB when dictated by budget constraints or when noise intrusion from other sources represents a limiting condition.

² An acoustical expert should be consulted for guidance on these critical spaces.

Table 4 Recommended Category Classification and Suggested Noise Criteria Range for Steady Background Noise as Heard in Various Indoor Functional Activity Areas.¹

STC is not necessarily the best performance specification for windows as it is often a poor predictor of sound insulation for low frequency sources, such as mechanical system or transportation noise. The OITC (Outdoor- Indoor Transmission Class) rating system based on ASTM E 1332 is relatively new, and it was designed to assess a building façade element, such as a window, when exposed to a standard spectrum of low frequency air and truck transportation noise ranging from 80 to 4000 Hz (see ASTM Guide E 966). Therefore, it is a better measure of a window system's performance than STC, especially when traffic noise is the principal concern. The numeric value representation of OITC tends to be lower than the STC rating.

There are many options available for acoustical glazing, so it is important to make the right choice—especially if the building is exposed to significant exterior noise and the interior spaces are noise sensitive. The use of doublepane insulating glass is not adequate for many projects. Even single- or double-laminated insulating glass may not be adequate, especially at low outside temperatures, where regular PVB-laminated glass will yield a performance similar to that of non-laminated glass.

The sound-transmission loss through a door depends on the material and construction of the door and the effectiveness of the seal between the door and its frame. There is a mass law dependence of STC on weight (psf) for both wood and steel doors. The approximate relationships are:

For steel doors: $STC = 15 + 27 \log W$

For wood doors: $STC = 12 + 32 \log W$

where W = weight of the door, psf.

These relationships are purely empirical and a large deviation can be expected for any given door. ASTM E 1408 can be used to determine the acoustical performance of doors.

For best results, the distances between adjacent door and/or window openings should be maximized, staggered when possible, and held to a minimum area. Minimizing openings allows the wall to retain the acoustical properties of the precast concrete. The design characteristics of the door or window systems must be analyzed prior to specification. Such qualities as frame design, door construction, and glazing thickness are vital performance criteria. Installation procedures must be exact and care should be given to the framing of each opening. Gaskets, weatherstripping, and raised thresholds serve as both thermal and acoustical seals and are recommended.

Figure 8 can be used to calculate the effective acoustic isolation of a wall system that contains a composite of elements, each with known individual transmission loss data (TL). (For purposes of approximation, STC values can be used in place of TL values.)

Example: Composite Wall Insulation Criteria

To complete the office building wall acoustical design from page 41 assume the following:

1. The glazing area represents 10% of the exterior wall area.
2. The windows will be double glazed with a 40 STC acoustical insulation rating.

The problem now becomes the test of determining the combined effect of the concrete-glass combination and a re-determination of criteria compliance (see Sound Pressure Level 3).

The maximum deficiency is 3 dB and occurs at only one frequency point. The 6 in. (150 mm) precast concrete wall with double-glazed windows will provide the required acoustical insula-

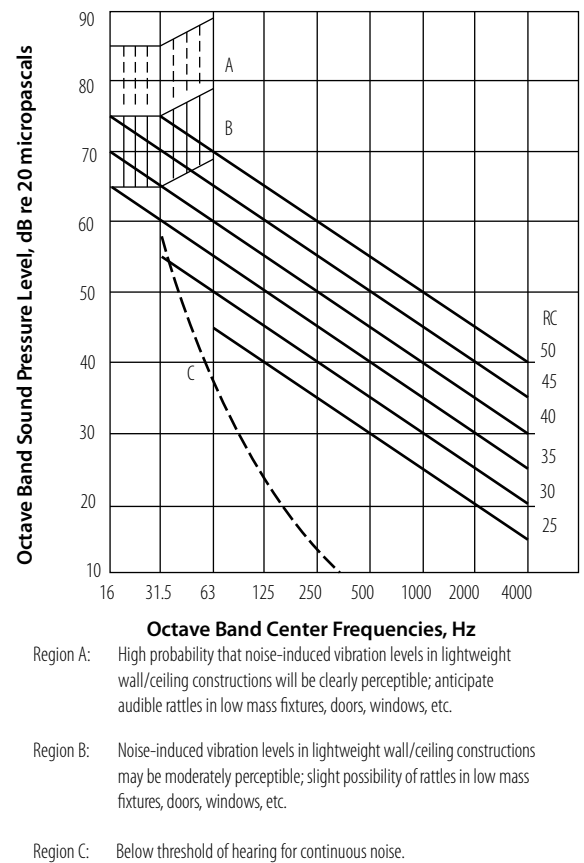

Figure 5 Room criteria (RC) curves.

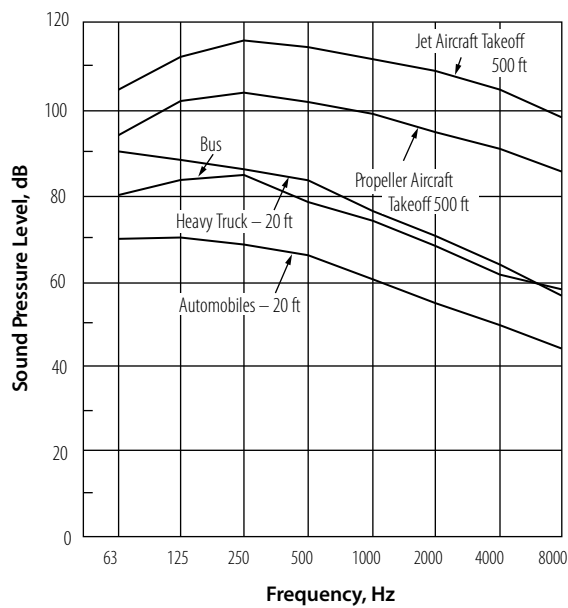

Figure 6 Sound pressure levels — exterior noise sources.

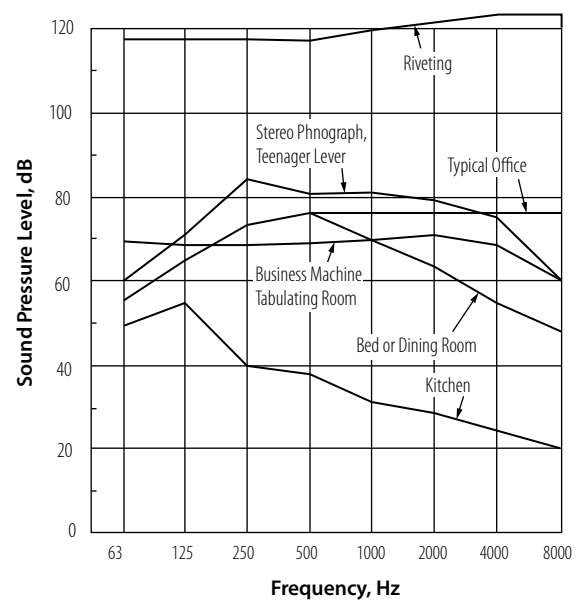

Figure 7 Sound pressure levels — interior noise sources.

tion.

Floor-ceiling assembly acoustical insulation requirements are determined in the same manner as walls by using Fig. 2 and 8.

Leaks and Flanking

Performance of a building section with an otherwise adequate STC can be seriously reduced by a relatively small hole (or any other path) that allows sound to bypass the acoustical barrier. All noise that reaches a space by paths other than through the primary barrier is called flanking noise. Common flanking paths are openings around doors or windows, electrical outlets, tele-

Sound Pressure Level – (dB)								
Frequency (Hz)	63	125	250	500	1000	2000	4000	8000
Bus traffic source noise (Fig. 6)	80	83	85	78	74	68	62	58
Private office noise criteria – NC 35 (Fig. 4)	60	52	45	40	36	34	33	32
Required insulation	20	31	40	38	38	34	29	26

Sound Pressure Level 1.

Sound Pressure Level – (dB)						
Frequency (Hz)	125	250	500	1000	2000	4000
Required insulation	31	40	38	38	34	29
6 in. precast concrete solid concrete wall (Fig. 2)	38	43	52	59	67	72
Deficiencies	-	-	-	-	-	-

Sound Pressure Level 2.

Sound Pressure Level – (dB)						
Frequency (Hz)	125	250	500	1000	2000	4000
6 in. precast solid concrete wall (Fig. 2)	38	43	52	59	67	72
Double-glazed windows (Table 5)	17	33	40	41	40	54
Correction (Fig. 8)	10	3	4	9	16	9
Combined transmission loss 28	40	48	50	51	63	
Insulation requirements	31	40	38	38	34	29
Deficiencies - 3	—	—	—	—	—	
Note: 1 in. = 25.4 mm						

Sound Pressure Level 3.

phone and television connections, and pipe and duct penetrations. Suspended ceilings in rooms where walls do not extend from the ceiling to the roof or floor above also allow sound to travel to adjacent rooms by flanking.

Anticipation and prevention of leaks begins at the design stage. Flanking paths (gaps) at the perimeters of interior precast concrete walls and floors are generally sealed during construction with grout or drypack. All openings around penetrations through walls or floors should be as small as possible and must be sealed airtight. The higher the required STC of the barrier, the greater the importance of sealing all openings.

Perimeter leakage commonly occurs at the intersection between an exterior cladding panel and a floor slab. It is of vital importance to seal this gap to retain the acoustical integrity of the system and provide the required fire stop between floors. One way to seal the gap is to place a 4 pcf (64 kg/m³) density mineral wool blanket between the floor slab and the exterior wall. **Figure 9** demonstrates the acoustical isolation effects of this treatment. An enhancement to Fig. 9 would be to recess the insulation below the floor plane and fill the recess with smoke stop elastomeric

Sound Transmission Class (STC)															
Type and Overall Thickness, in.	Inside Lite, in.		Construction Space, in.		Outside Lite, in.		STC		OITC						
5/8 Insulated Glass	1/8		3/8		1/8		31		26						
1/4 Plate or Float	—		—		1/4		31		29						
1/2 Plate or Float	—		—		1/2		36		32						
1 Insulated glass	1/4		1/2 Air space		1/4		35		28-30						
1/4 Laminated	1/4		0.030 Vinyl		1/8		35		—						
1 1/2 Insulated glass	1/4		9/16 Air space		3/16		37		28-30						
3/4 Plate or Float	—		—		3/4		36		—						
1 Insulated glass	1/4 Laminated		1/2 Air space		1/4		39		31						
1 Plate or Float	—		—		1		37		—						
2 3/4 Insulated glass	1/4		2 Air space		1/2		39		—						
1 Laminated Insulated glass	1/4		1/2 Air space		1/8 plus 1/8		41		32						
Transmission loss (dB)															
Frequency (Hz)															
125	160	200	250	315	400	500	630	800	1000	1250	1600	2000	2500	3150	4000
1/4 in. plate glass – 31 STC; 29 OITC															
25	25	24	28	26	29	31	33	34	34	35	34	30	27	32	37
1 in. insulating glass with 1/2 in. air space – 35 STC; 28 OITC															
24	29	22	22	25	30	33	35	38	40	42	42	37	37	43	46
1 in. insulating glass laminated with 1/2 in. air space – 39 STC; 31 OITC															
17	28	29	33	34	38	40	40	41	41	41	41	40	43	49	54

Table 5 Acoustical properties of glass.

sealant. Thereby improving not only the sound but the smoke resistance of the assembly.

Flanking paths can be minimized by:

1. Interrupting the continuous flow of energy with dissimilar materials, that is, expansion or control joints or air gaps.
2. Increasing the resistance to energy flow with floating floor systems, full height and/or double

partitions, and suspended ceilings.

3. Using primary barriers, which are less subject to the creation of flanking paths. Although not easily quantified, an inverse relationship exists between the performance of an element as a primary barrier and its propensity to transmit flanking sound. In other words, the probability of existing flanking paths in a concrete structure is much less than in a structure with steel or wood framing.

If the acoustical design is balanced, the maximum amount of acoustic energy reaching a space via flanking should not equal the energy transmitted through the primary barriers. In exterior walls, the proper application of sealant and backup materials in the joints between units will not allow sound to flank the wall.

Impact Sound Transmission of Concrete Floors

Noise from footsteps and other impacts is a common source of annoyance in buildings. Impact noise is more difficult to control than airborne sound because energy transfer is much more efficient when the vibrating or impacting source touches and directly excites the surfaces of a building. In general, thickness or unit weight of concrete does not greatly affect the transmission of impact sounds.

The test method used to evaluate systems for impact sound insulation is described in ASTM E492, *Laboratory Measurement of Impact Sound Transmission Using the Tapping Machine*. As with the airborne standard, measurements are made at 16 one-third-octave intervals but in the range from 100 Hz to 3150 Hz. For performance specification purposes, the single-number Impact Insulation Class (IIC) is used.

Structural concrete floors in combination with resilient materials effectively control impact sound. One simple solution consists of good carpeting on resilient padding. Table 6 shows that a carpet and pad over a bare slab will significantly increase the impact-noise reduction. The overall efficiency varies according to the characteristics of the carpeting and padding such as resilience, thickness, and weight. So-called resilient flooring materials, such as linoleum, rubber, asphalt, vinyl, etc., are not entirely satisfactory when applied directly on concrete, nor are parquet or strip wood floors.

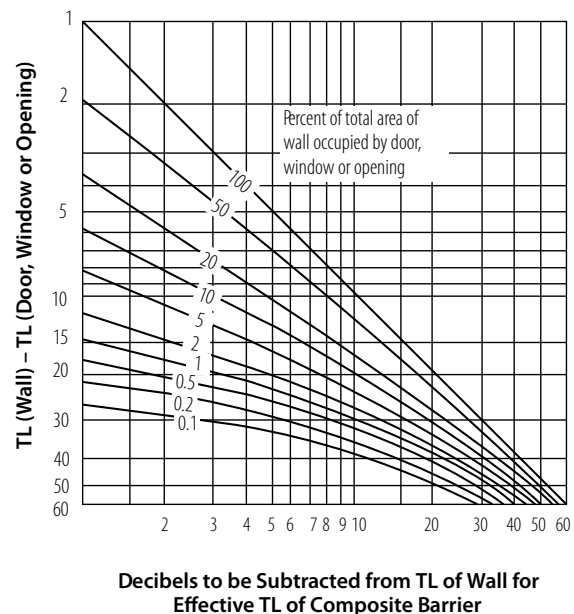
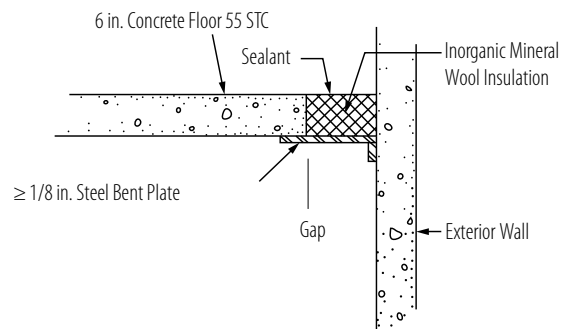

Figure 8 Chart for calculating the effective transmission loss of a composite barrier.



Combined Transmission Loss	
No closure	14 STC
With steel bent plate closure	28 STC
With 4 in. thick safing insulation steel bent plate added	30 STC
With 6 in. thick safing insulation steel bent plate added	38 STC
With 6 in. thick safing insulation steel bent plate added	45 STC

Figure 9 Effect of safing insulation seals.

Assembly No.	Description Floor-Ceiling Systems	STC	IIC
1	8 in. hollow-core prestressed units, 57 psf	50	28
2	Assembly 1 with carpet and pad, 58 psf	50	73
3	8 in. hollow-core prestressed units with 1/2 in. wood-block flooring adhered directly, 58 psf	51	47
4	Assembly 3 except 1/2 in. wood-block flooring adhered to 1/2 in. sound-deadening board underlayment adhered to concrete, 60 psf	52	55
5	Assembly 4 with acoustical ceiling, 62 psf	59	61
6	Assembly 1 with quarry tile, 1 1/4 in. reinforced mortar bed with 0.4 in. nylon and carbon black spinerette matting, 76 psf	60	54
7	Assembly 6 with suspended 5/8 in. gypsum board ceiling with 3 1/2 in. insulation, 78.8 psf	61	62
8	14 in. prestressed tees with 2 in. concrete topping, 75 psf	54	24
9	Assembly 8 with carpet and pad, 76 psf	54	72
10	Assembly 8 with resiliently suspended acoustical ceiling with 1 1/2 in. mineral fiber blanket above, 77 psf	59	51
11	Assembly 10 with carpet and pad, 78 psf	59	82
12	4 in. flat slabs, 54 psf	49	25
13	5 in. flat slabs, 60 psf	52 ^a	24
14	5 in. flat slab concrete with carpet and pad, 61 psf	52 ^a	68
15	6 in. flat slabs, 75 psf	55	34
16	8 in. flat slabs, 95 psf	58	34 ^a
17	10 in. flat slabs, 120 psf	59 ^a	31
18	10 in. flat slab concrete with carpet and pad, 121 psf	59 ^a	74

a. Estimated values.

Table 6 Airborne sound transmission loss (STC) and impact insulation class (IIC) rating from tests of precast concrete assemblies.

whether or not there is sound-absorbing material present in the cavity.

Table 6 presents the ratings for various precast concrete floor-ceiling assemblies. The effects of various assembly treatments on sound transmission can also be predicted from the results of previous tests as shown in **Table 7**. The improvements are additive, but in some cases the total effect may be slightly less than the sum. 

Treatment	Increase in Ratings	
	Airborne (STC)	Impact (IIC)
2 in. concrete toppings (24 psf)	3	0
Carpets and pads	0	43 to 56
Vinyl tile	0	3
1/2 in. wood block adhered to concrete	0	20
1/2 in. wood block and resilient fiber underlayment adhered to concrete	4	26
Floating concrete floor on fiberboard	7	15
Wood floor, sleepers on concrete	5	15
Wood floor on fiberboard	10	20
Acoustical ceiling resiliently mounted if added to floor with carpet	5 5	27 10
Plaster or gypsum board ceiling resiliently mounted with insulation in space above ceiling	10 13	8 13

Table 7 Typical improvement for floor and ceiling treatments used with precast concrete elements.

Impact sound also may be controlled by providing a discontinuity in the structure as would be obtained by adding a ceiling supported on resilient hangers below a concrete slab. The improvement depends on the method of support, the cavity depth, the weight of the ceiling, and the amount of sound-absorbing material present in the cavity. A floating floor consisting of a second layer of concrete cast over resilient pads, insulation boards, or mastic can also improve the IIC ratings. The value of IIC obtained depends on the properties of the resilient material used to support the floating layer, the depth of the cavity below the floating slab, the weight and properties of the slab, and



designer's notebook



Precast/Prestressed Concrete Institute
200 West Adams Street | Suite 2100 | Chicago, IL 60606-5230
Phone: 312-786-0300 | Fax: 312-621-1114 | www.pci.org